

The Piocon logo features the word "piocon" in a lowercase, red, sans-serif font. The letter "i" is stylized with a red dot above it and a red dot below it. The background is a dark red gradient with a horizontal line of white dots below the logo.

EXPLOITING TECHNOLOGY for your advantage.

## **SSL, Load Balancers, Rewrite, Redirect, and More Advanced Configuration**

Dan Norris  
Practice Manager  
Piocon Technologies, Inc.  
[dnorris@piocon.com](mailto:dnorris@piocon.com)

Co-created with Matt Topper

---

# Agenda

- Enterprise Deployments
  - Deployment Types
  - High Availability
- SSL
- Rewriting URLs
- Portal & Networking
- Tips For The FMW Architect
- Q&A

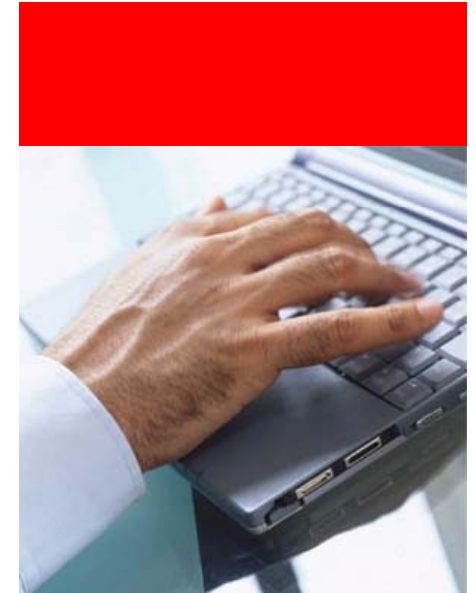

---

## Who is Dan?



- Virgo
- Scuba Diver (PADI Advanced OW, Nitrox)
- Over 21, under 35
- Oracle DBA & UNIX Admin background
- Certifiable: OCM, ACE Director, RHCE
- Consultant, mostly fixing things that are broken
- Active community participant: RAC SIG, SIG Council, DBA Track Manager, blogger, tweeter
- ESA Practice Manager at Piocon Technologies

---

## Confused?



- 9iAS 1.0.2.2
- 10g AS R1 9.0.4
- 10g AS R2 10.1.2.0.2
- 10g AS R3 10.1.3.1.0 (SOA Suite)
- 10g AS R3 10.1.3.2.0 (Web Center)
- 10g AS R3 10.1.3.3.0 (patch set? BIEE?)
- 10g AS 10.1.4 (Portal upgrade)
- Identity Management 9.1 (OIM)
- Identity Management 10.1.4.0.1 (OID, SSO, DAS)

---

# Scalability

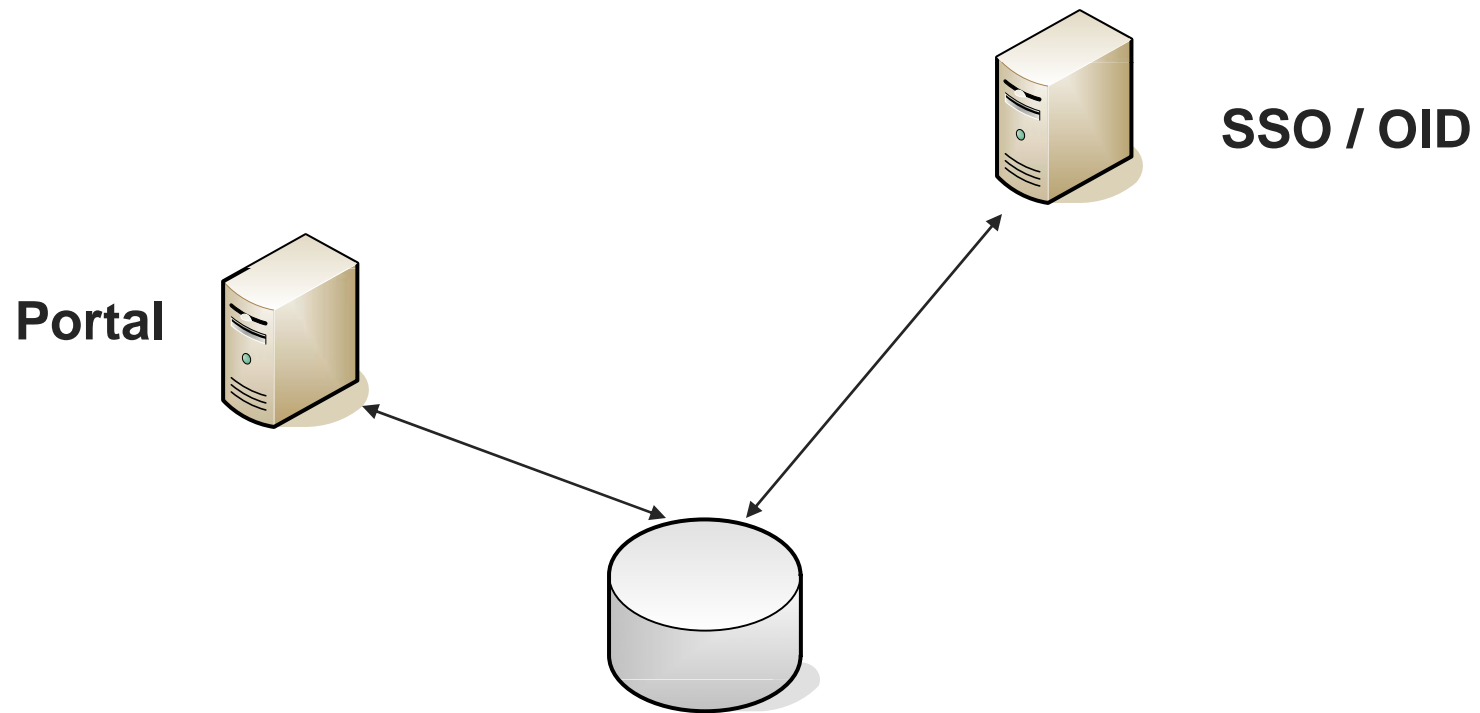

# Scalability

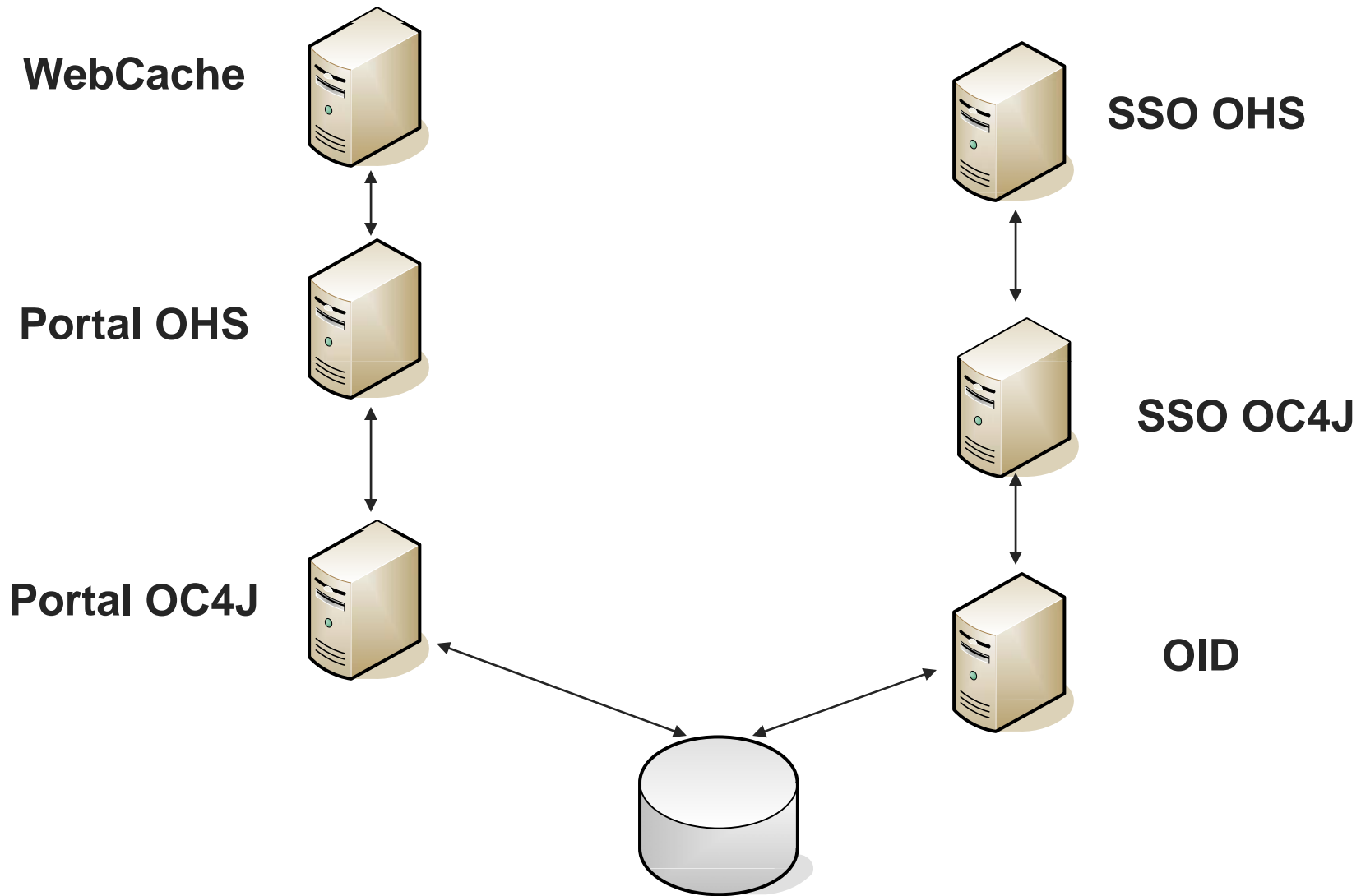

# High Availability

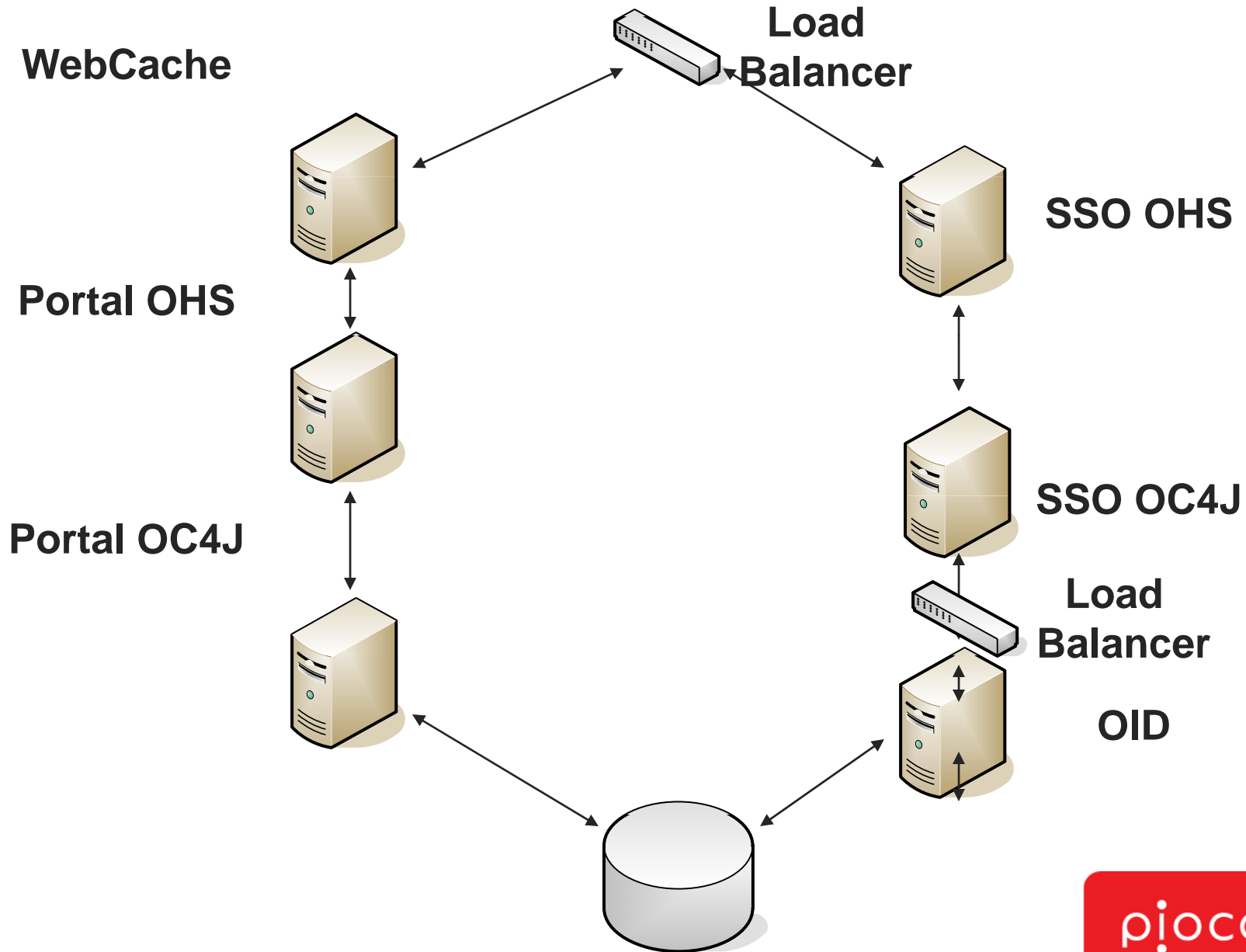

# High Availability

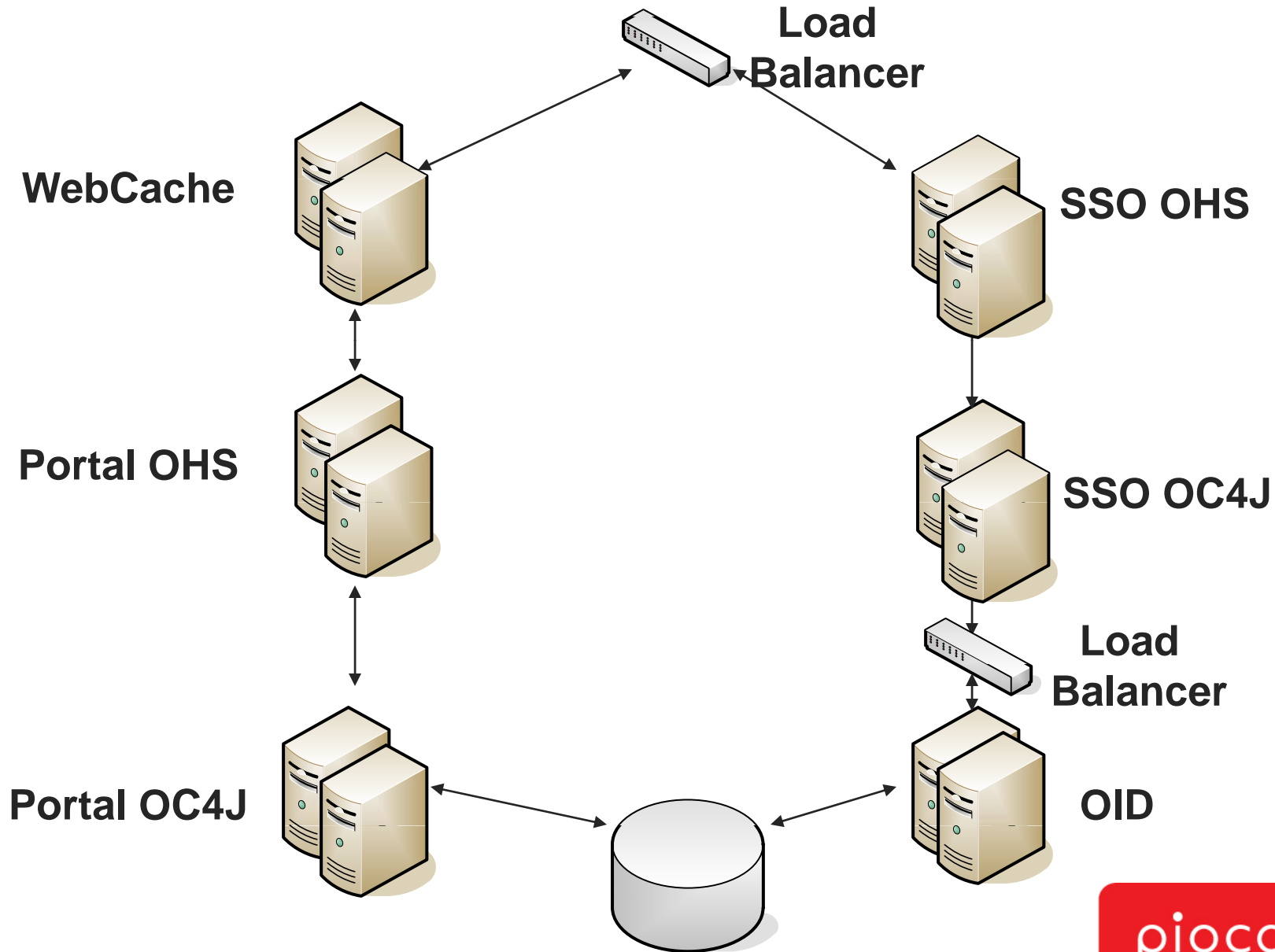

# High Availability

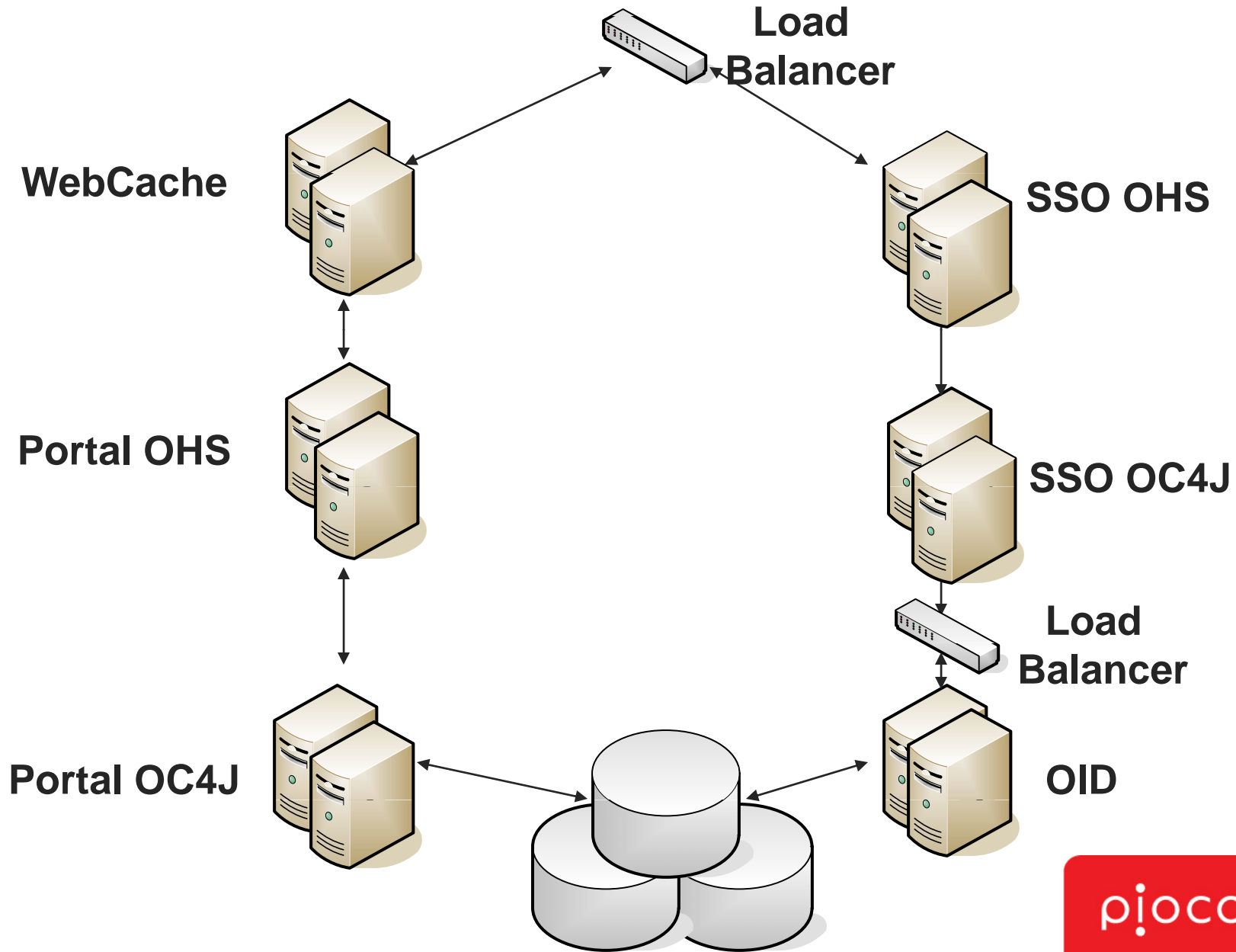

---

# Redundancy for Oracle FM Architectures: TOPOLOGIES



# Fusion Middleware Clusters in a Maximum Availability Architecture

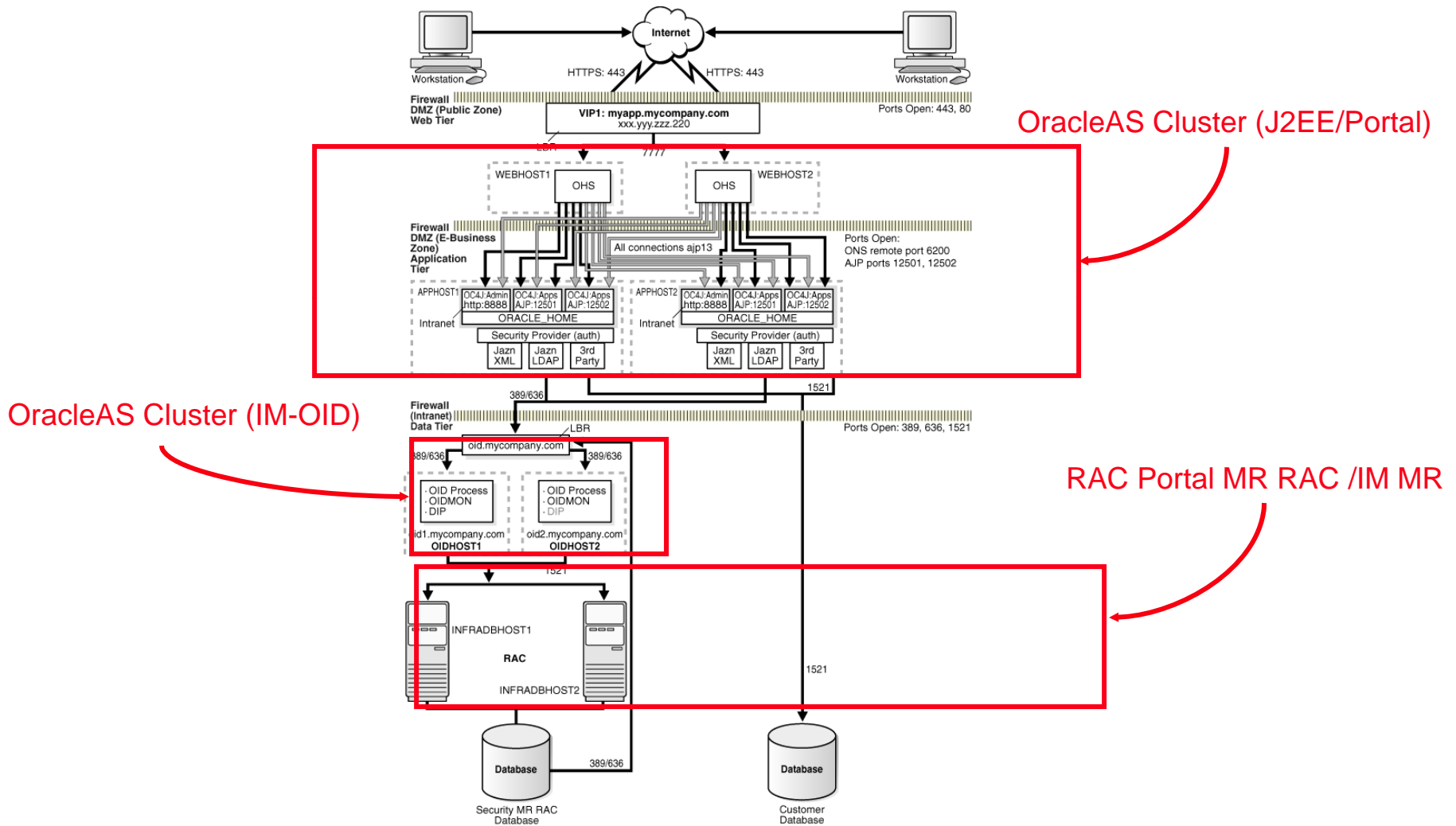

# Fusion Middleware Clusters in a Maximum Availability Architecture with SSO

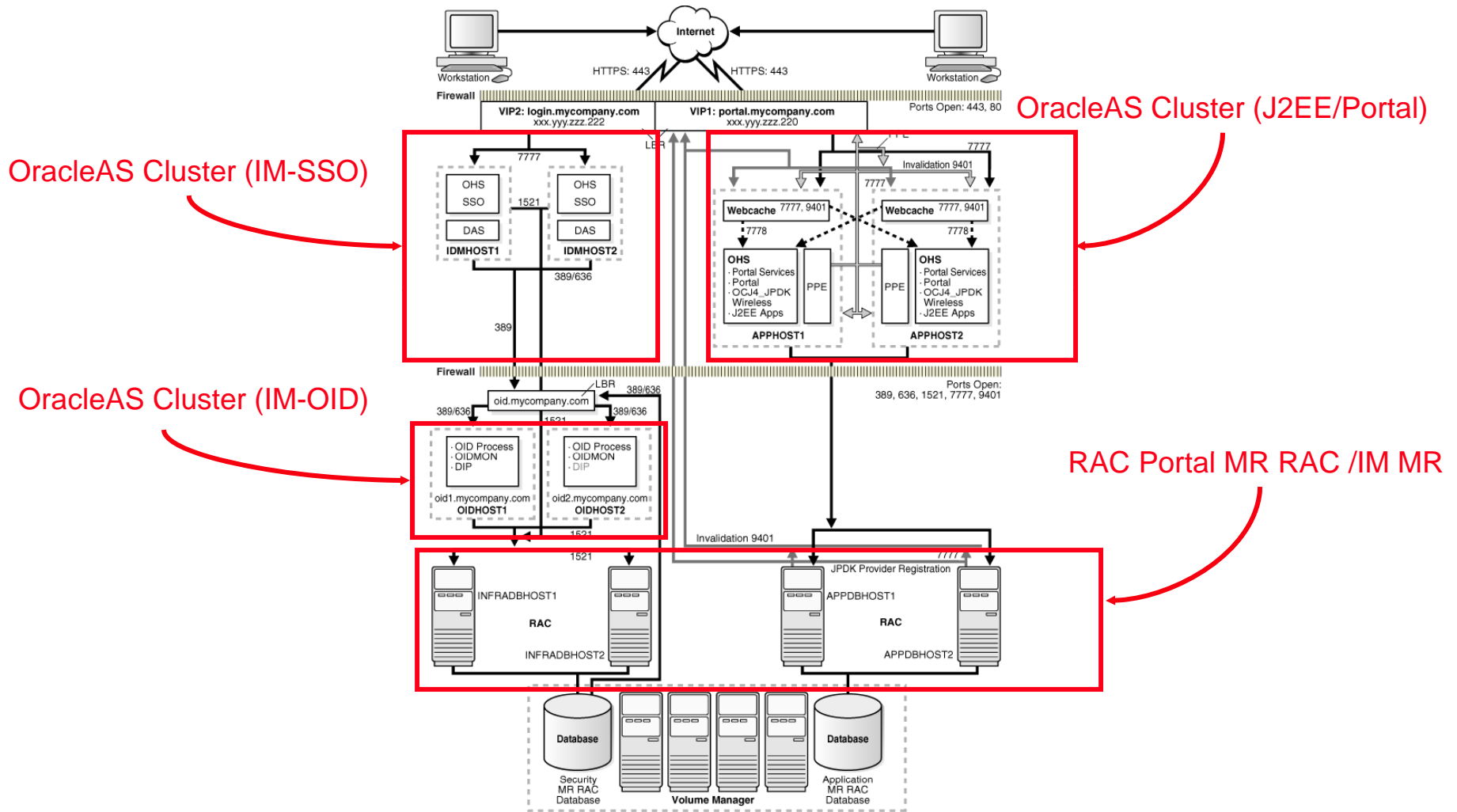

# Fusion Middleware Clusters in a Maximum Availability Architecture SOA Components specific

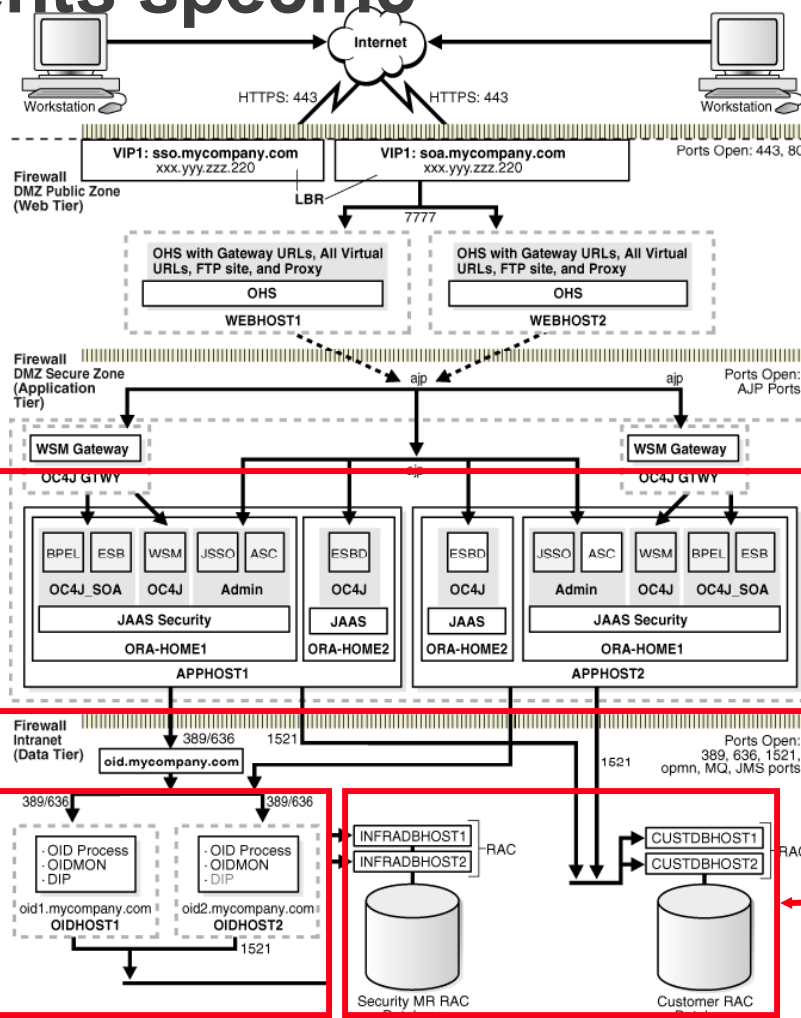

OracleAS Cluster (SOA)

OracleAS Cluster (IM-OID)

RAC Portal MR RAC /IM MR





# Secure Sockets Layer (SSL)

# Protocols in Fusion Middleware



 = can use SSL

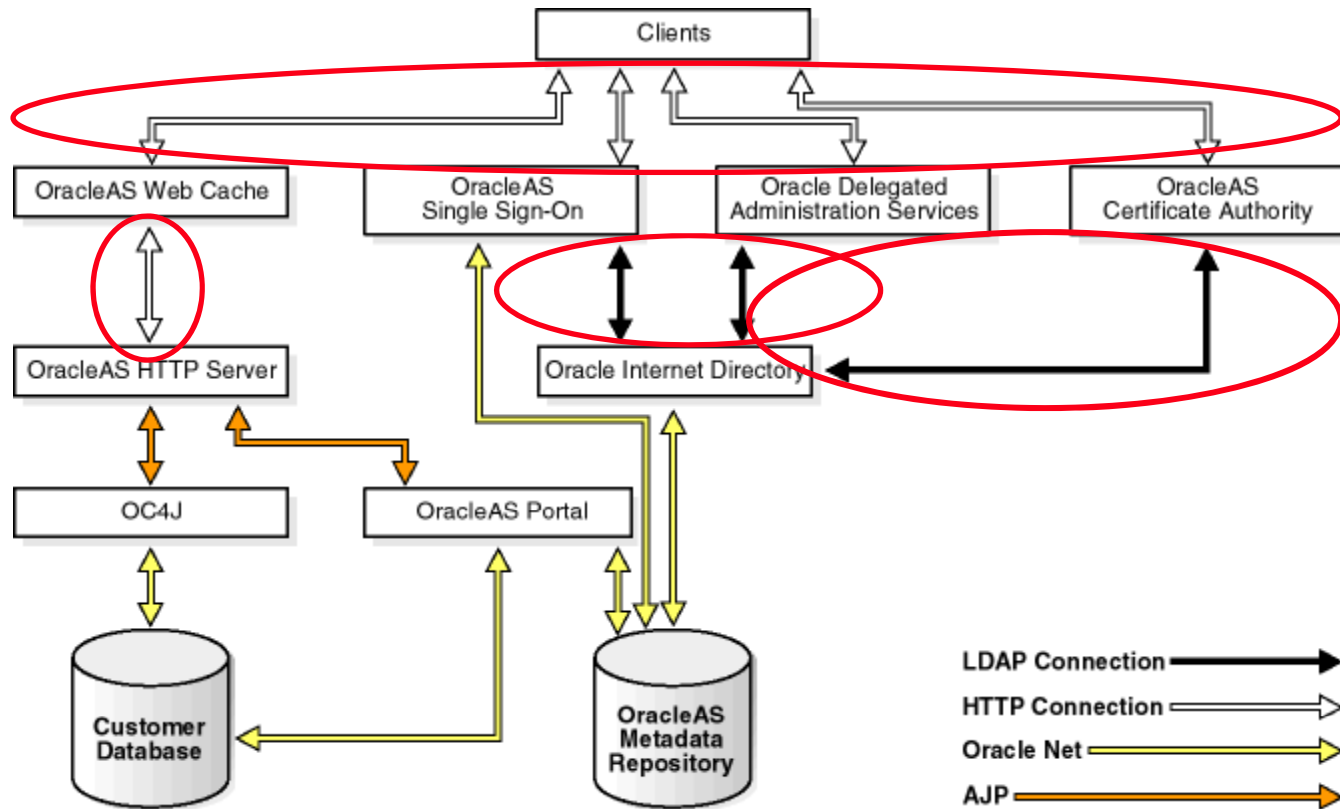

---

## Oracle Wallets



- For Oracle components (WebCache, HTTP Server, OID), Oracle Wallet is where your SSL certificate (and private key) is stored
- You must create and maintain the wallet(s)
- Wallet can be shared/copied between nodes. Certificates are based on hostname used by client, not the actual server hostname (significant in load balanced configurations)
- Oracle Wallet Manager (owm) is the tool used to manage wallets through OAS 10g.

---

## SSL Configuration Options



- Browser -> (HTTPS) -> Load Balancer -> (HTTP) -> WebCache -> (HTTP) -> HTTP Server
- Browser -> (HTTPS) -> WebCache -> (HTTP) -> HTTP Server
- Browser -> (HTTPS) -> WebCache -> (HTTPS) -> HTTP Server
- Browser -> (HTTPS) -> HTTP Server

# Common Configuration Scenarios

## SSL Termination at LB for SSO/DAS

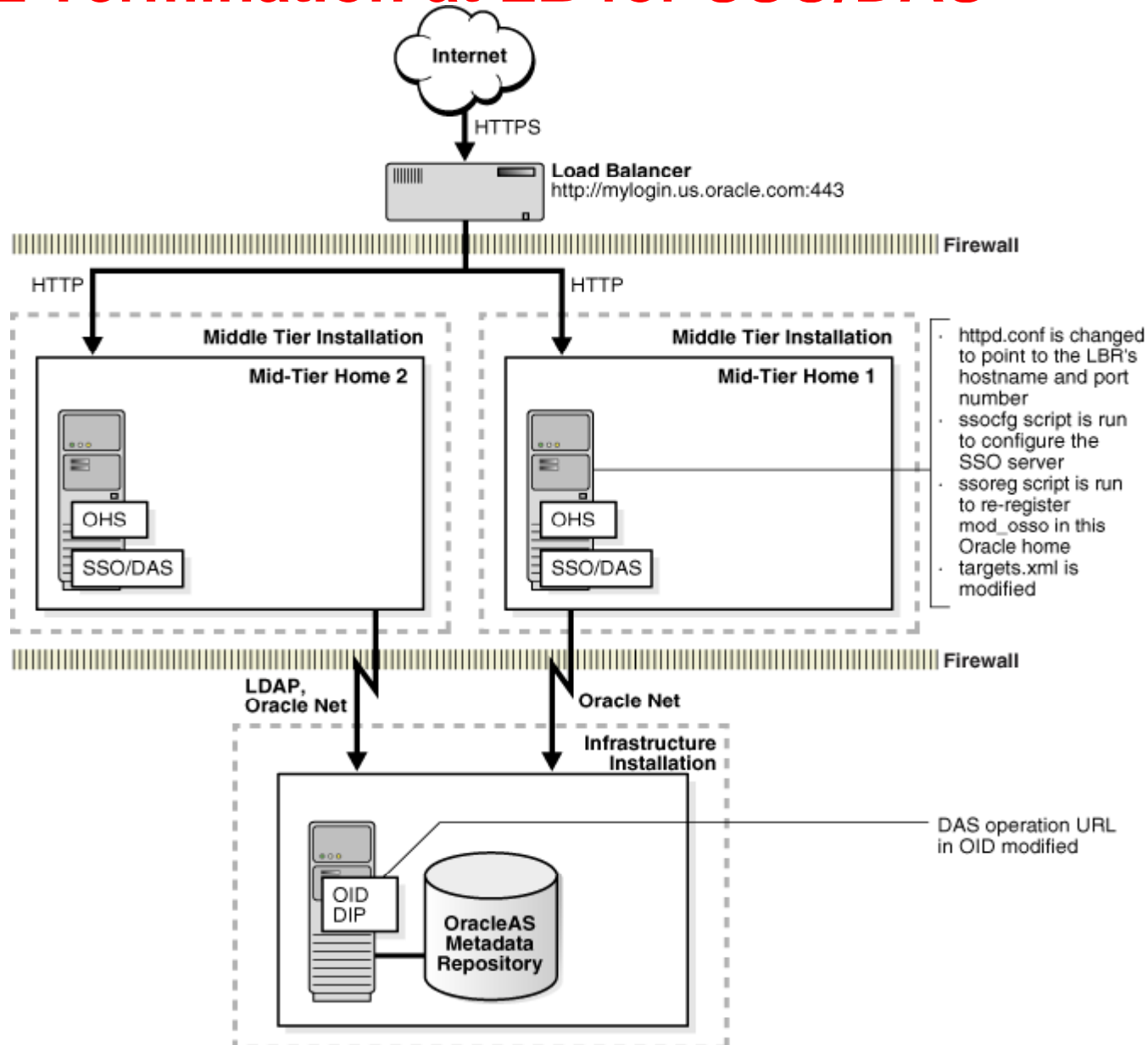

# Common Configuration Scenarios

## SSL Termination at LB for Portal

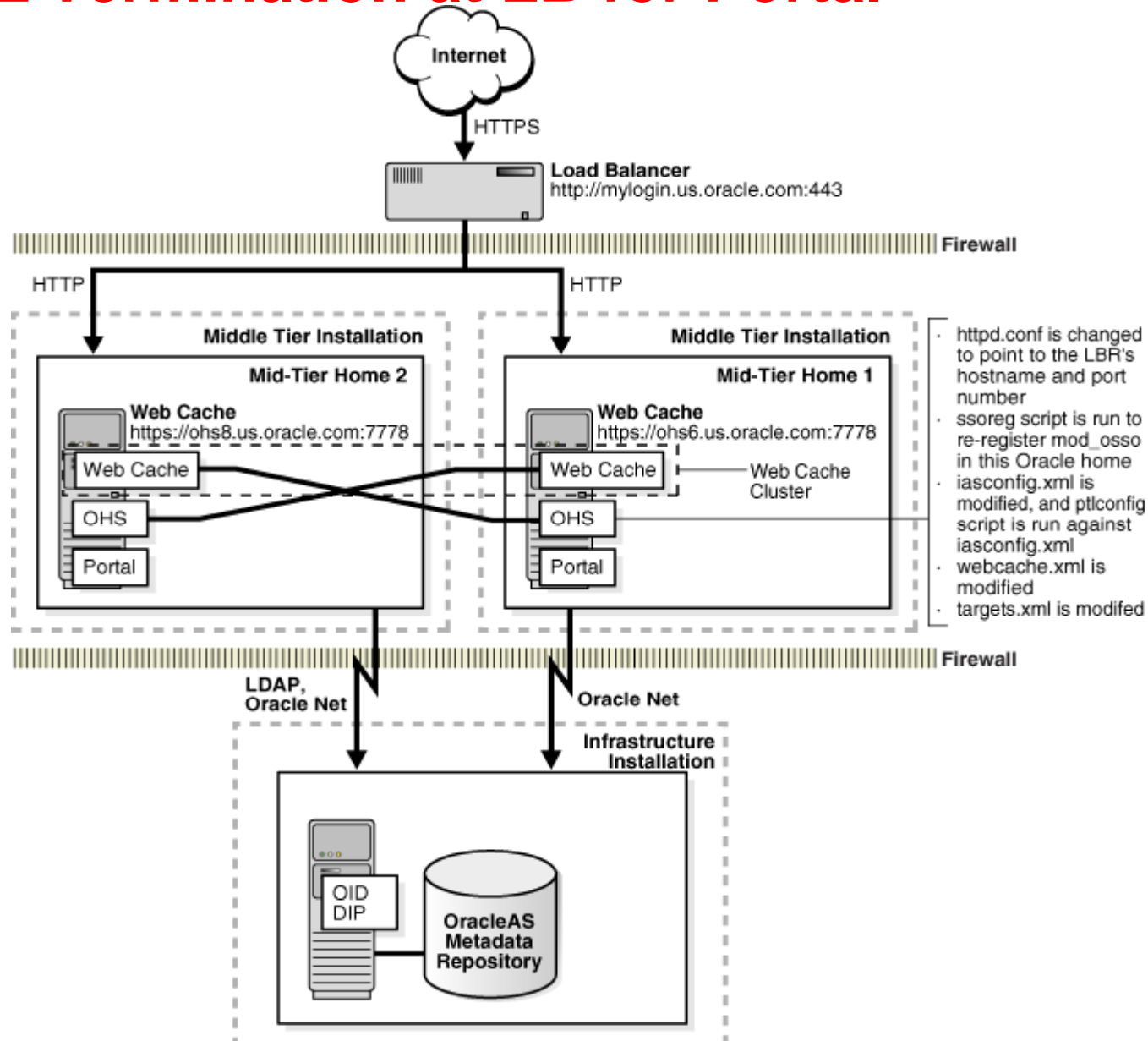

# Common Configuration Scenarios

## SSL Termination at HTTP Server

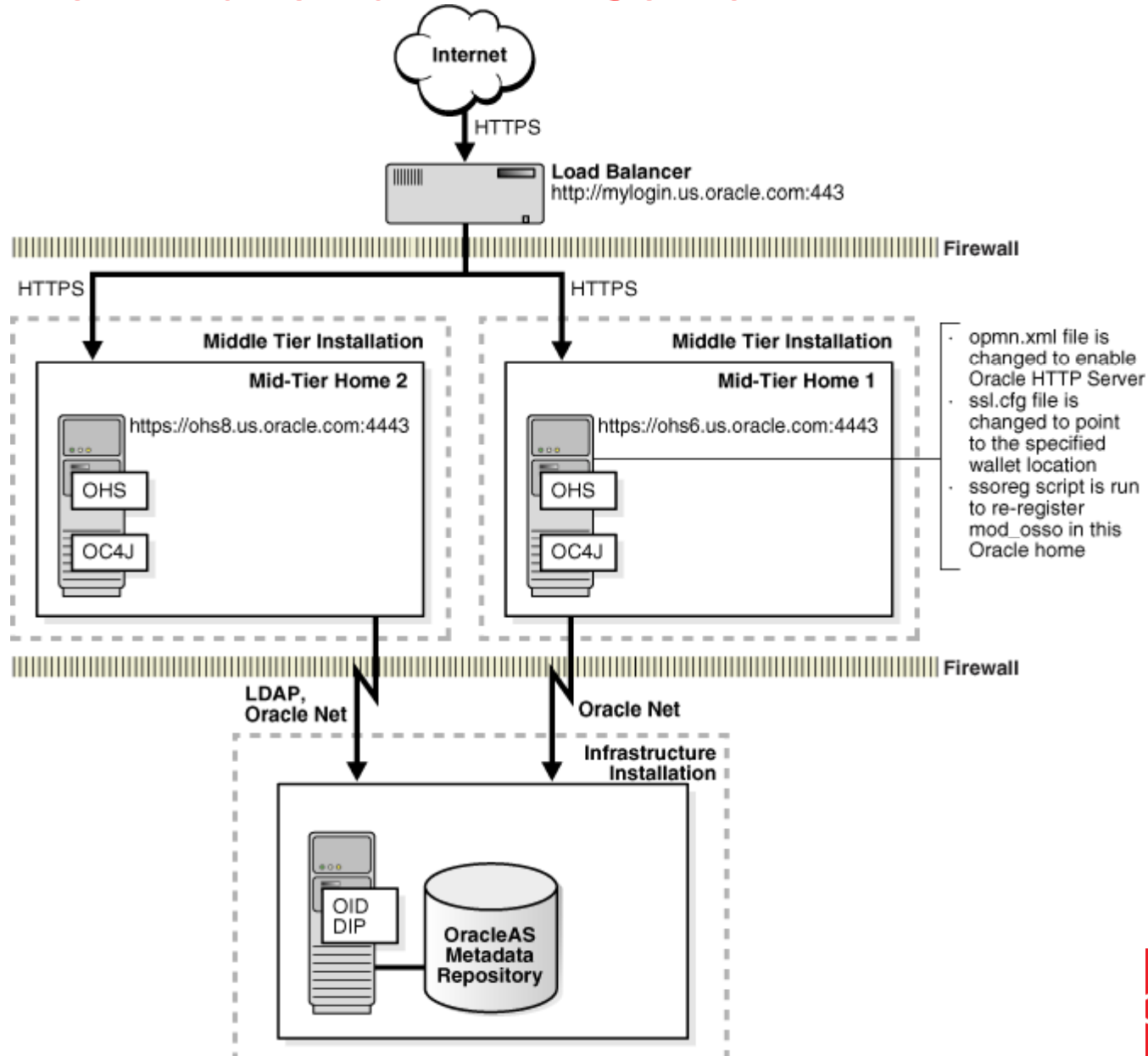

# Common Configuration Scenarios

## SSL Termination at WebCache

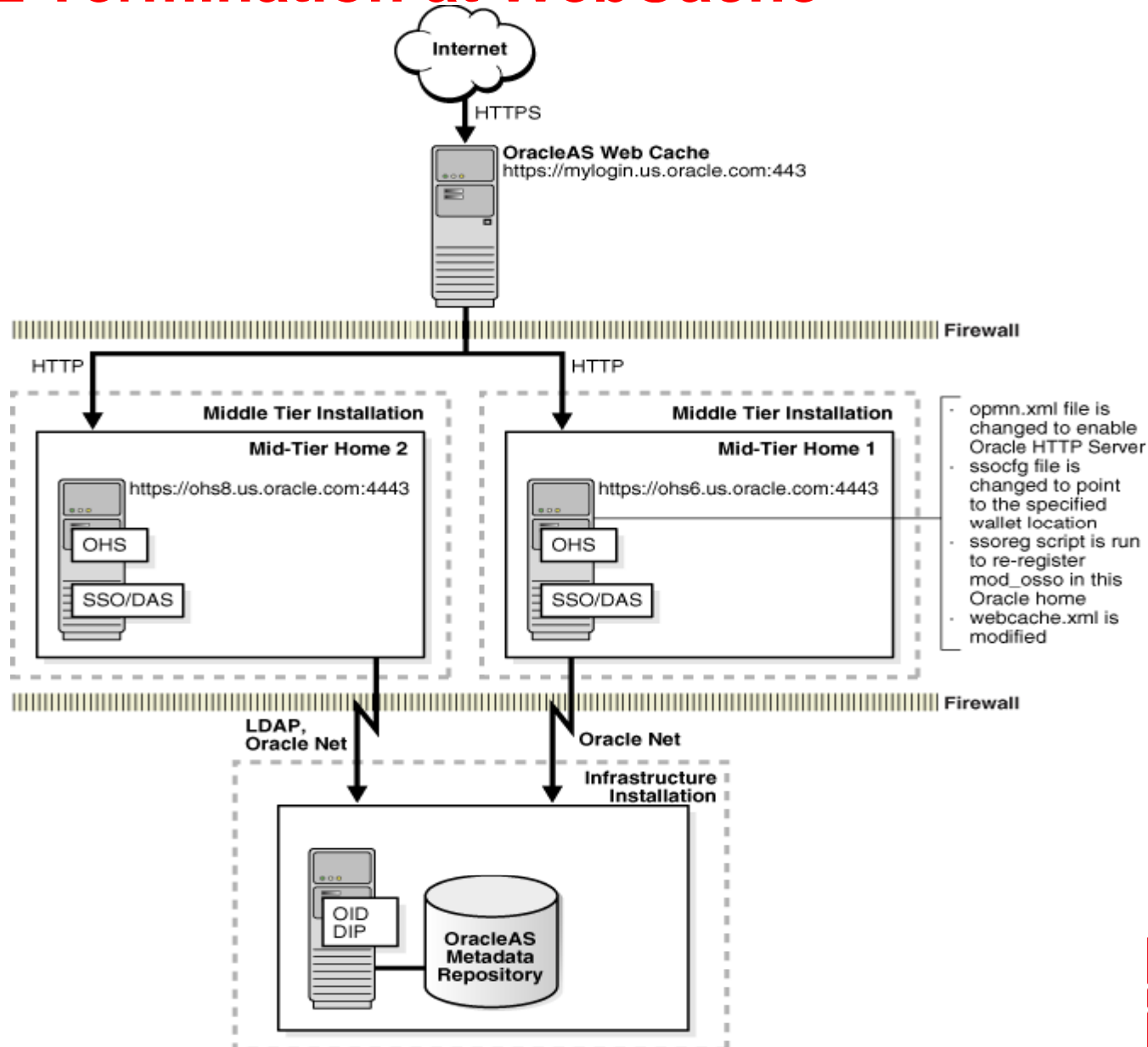



# Rewriting URLs

---

## Rewriting URLs



- `mod_rewrite` is the module employed
- `RewriteEngine`, `RewriteCond` `RewriteRule` are the main directives used
- `RewriteRule` has flags
  - R – external Redirect (302 to browser)
  - L – Last rule, stop processing
  - PT – Pass Through: hand the results of this rule to other modules for further processing, response
- Rewrite directives are not inherited by `VirtualHost` containers like some other directives (`RewriteEngine on` & `RewriteOptions inherit` will help)

---

# Rewriting URLs

## An Example



```
1) Alias /tpsredirect "/web/tps"  
2) RewriteRule ^/$ https://tps.dannorris.com/tpsredirect [R,L]  
3) RewriteCond %{REQUEST_URI} !^/tpsredirect  
4) RewriteCond %{REQUEST_URI} !^/tps/  
5) RewriteRule ^/(.*) /tps/$1 [PT]
```

- Line 1 is referenced later
- Line 2 will redirect any requests for the root page of the site to the URL shown. This will be a 302 redirect [R] and if matched, this is the last rule processed [L].
- Line 3 is true if the request does not start with /tpsredirect
- Line 4 is true if the request does not start with /tps and is combined with the result of Line 3 (AND)
- Line 5 is always matched, but only used if 3 and 4 are true and prefixes the request with /tps



# Portal & Networking



---

# Portal Network Architecture

## Things To Know



- Portal 10.1.2 and below used recursive HTTP requests **from the database** to render portlets
  - This may impact firewall rules
  - This will also be governed by the Parallel Page Engine (PPE) settings
- Portal 10.1.4 changed the architecture to make portlet rendering happen entirely in the middle tier—still uses DB for metadata, but no outbound portlet rendering requests



# Concluding Tips & Tricks

---

## Tips & Tricks



1. When debugging, eliminate all unnecessary components
2. Keep good notes and/or logs of every configuration change, you may want to go back and there are lots of moving parts (see #1)
3. Prepare test plans in advance, know what is necessary and what things are optional (browsers, OS platforms, load tests, etc)

---

## Tips & Tricks



4. Use a whiteboard when too many components are involved. Sometimes drawing it the old fashioned way exposes the problem. If you can't draw the architecture, learn more until you can.
5. What's your best lesson learned or tip?



The Piocon logo features the word "piocon" in a lowercase, rounded, red sans-serif font. The letter "i" has a red dot above it and a red dot below it. The background is a dark red gradient with a horizontal line of white dots below the logo.

EXPLOITING TECHNOLOGY for your advantage.

## **SSL, Load Balancers, Rewrite, Redirect, and More Advanced Configuration**

Dan Norris  
Practice Manager  
Piocon Technologies, Inc.  
[dnorris@piocon.com](mailto:dnorris@piocon.com)

Co-created with Matt Topper